



MilSpecWest
THE VERY BEST IN MICRO INTERCONNECTING PRODUCTS

888-428-2188
milspecwest.com

5015 STYLE CONNECTORS



Specializing in Aerospace, Marine and Defense

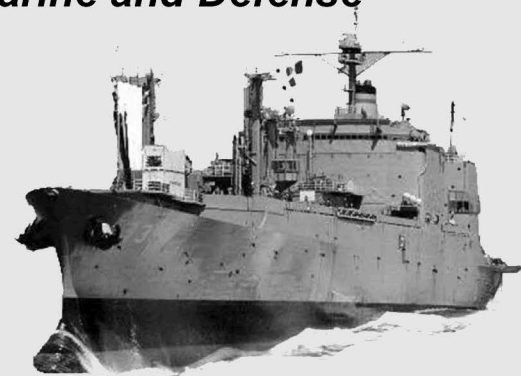

Introduction

MSW 5015 Style Connectors were designed for a wide range of both military and general industrial applications. With advantages of high quality, intermateability, reliability and low price, MSW 5015 Style Connectors are designed, manufactured and tested to the MIL-DTL-5015 Military Detailed Specification

Applications

- Railroad Equipment
- Industrial Machinery
- Engines
- Battery Systems
- Motion Control
- Power Generators
- Mobile Equipments
- Earth Moving Equipment

Connector design

MIL-DTL-5015 series applies to the circular threaded electrical solder-contact connectors. Shell is made through aluminum alloy diecasting with zinc plating and olive drab chromate finish protecting the shell against environmental influences.

These connectors operate in temperatures of -55°C to $+125^{\circ}\text{C}$ (-67°F to $+257^{\circ}\text{F}$) under the harshest possible conditions.

The various classes and types of MSW connectors are intended for application as follows:

- MSW3100** Receptacle intended for wall or bulkhead mounting and for use with conduit or cable clamp.
- MSW3101** : Plug intended for use at the end of a cable where mounting provisions are not required.
- MSW3102** : Receptacle intended for mounting on shielding boxes and equipment cases. They have no fittings and are for use with open wiring. They are nonenvironmental and are intended for use on boxes where environmental seal is achieved by some other means.
- MSW3106** : Plug intended for use at the end of a cable to be mated with a receptacle.
- MSW3108** : 90° plug intended for use at the end of a cable where space does not permit the use of a straight plug.

Class A connectors are solid shell connectors intended for nonenvironmental applications.

Class B connectors have split shell connectors intended for nonenvironmental applications. The split shell provides greater accessibility to solder connections, as may be needed if the cable is contained in conduit.

Technical Data

Electrical Data

Contact rating

(Assembled in insulator)

Contact size	Current [A]
16	13
12	23
8	46
4	80
0	150

Insulation resistance

The insulation resistance to be tested per EIA364.21 and MIL-DTL-5015 3.18 test condition B; DC500V/5000M Ω min

Operating & Test voltage

The dielectric withstanding voltage to be tested per EIA364.20 and MIL-DTL-5015 3.11

Service rating	Test Voltage AC(rms)		Operating Voltage	
	sea level	70,000ft	DC	AC(rms)
Inst	1000	260	250	200
A	2000	360	700	500
D	2800	400	1250	900
E	3500	440	1750	1250
B	4500	480	2450	1750
C	7000	560	4200	3000

Contact resistance

Voltage drops to be tested with the coupling ring removed per EIA364.06 and MIL-DTL-5015 3.15

Contact size	Test current [A]	Potential drop max.mV	Contact resistance max.m Ω
16	13	49	6
12	23	42	3
8	46	26	1
4	80	23	0.5
0	150	21	0.2

Mechanical Features

Ambient temperature

-55°C/+125°C

Humidity

14-day 71°C \pm 2°C to 95% \pm 3% humidity testing per EIA364.31 Method II and MIL-DTL-5015 3.14

Durability

Test mating / unmating 100 times at the speed of max 60 times / hour.

Per EIA364.09 and MIL-DTL-5015 3.16

Salt spray

Unmated connectors and contacts meet 48hour exposure per EIA364.26 test condition letter B and MIL-DTL-5015 3.17

Sine vibration

10 μ s max at 10 to 500Hz(15g) discontinuity per EIA364.28 test condition II and MIL-DTL-5015 3.12.1

Shock

50g's/11ms duration, three major axes 10 μ s max discontinuity per EIA364.27 test condition A and MIL-DTL-5015 3.13

Contact retention

The contact retention to be tested per EIA364.29 and MIL-DTL-5015 3.10

Contact size	Test force N (lbs)
16	44.5 (10)
12	66.7 (15)
8	89.0 (20)
4	89.0 (20)
0	111.2 (25)

Contact engagement and separation forces

The Contact engagement and separation forces to be tested per EIA364.37 and MIL-DTL 5015 3.25

Contact mating end size	Contact engagement and separation force		
	Min N (lbs)	Average N (lbs)	MAX N (lbs)
16	0.6 (0.13)	2.06(0.46)	13.3 (3)
12	0.8 (0.18)	3.50(0.79)	22.2 (5)
8	1.4 (0.31)	-	44.5 (10)
4	2.8 (0.63)	-	66.7 (15)
0	4.2 (0.94)	-	89.0 (20)

Contact size

Contact size	Pin O.D [mm]	Solder pot [mm]
16	1.6	2.0
12	2.4	3.0
8	3.6	5.4
4	5.7	8.5
0	9.1	12.0

Wire sealing range

Contact size	Wire range accommodations			
	Insulation O.D limit	Wire size	Metric [mm ²]	Conductor [mm]
16	1.6~3.3	16~20	1.3max	1.25~1.7
12	2.9~4.3	12~14	3.5max	1.95~2.4
8	4.2~6.5	8~10	8.0max	4.3~4.8
4	6.9~9.4	4~6	22.0max	5.2~6.0
0	10.5~14.0	0~2	50.0max	9.6~10.7

Materials

Shell

Material	Aluminum alloy Die Castings & Aluminum alloy
Finish	Olive drab chromate coating over zinc plating
Alternative finish	Black coating over zinc plating(RoHS) Electroless nickel

Insulator and grommet

Insulator	Synthetic rubber & polychloroprene Synthetic plastic
Grommet	Synthetic rubber & polychloroprene

Contact

Material	Copper alloy
Finish	Silver plating Gold plating

Mating guide:

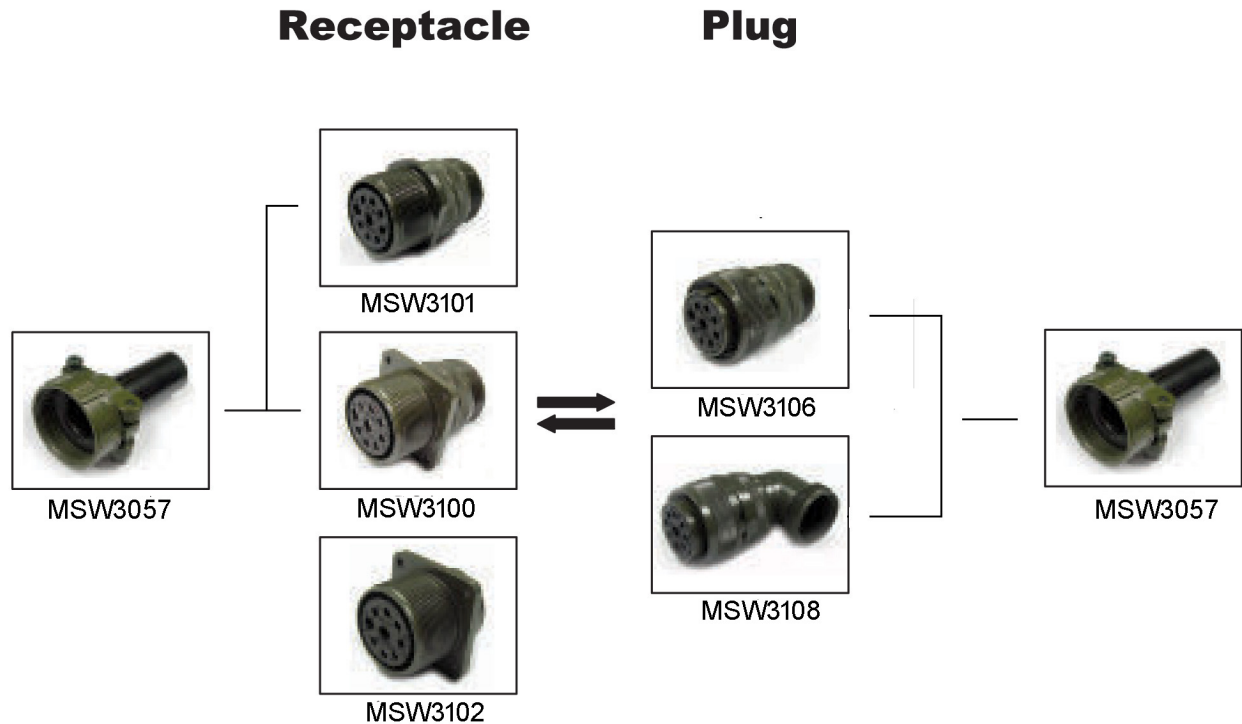

Pin or Socket Inserts

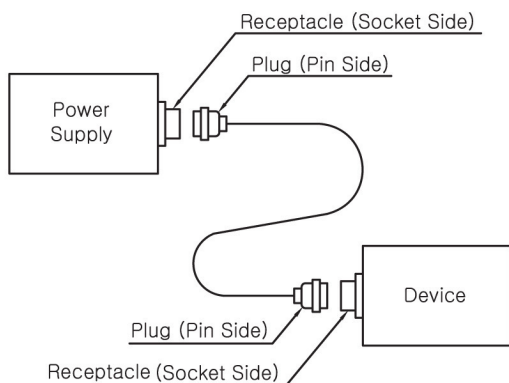

Connector combinations are formed with plugs and receptacles that are connected with pin and socket contacts. Either the receptacle or the plug can be provided with pin inserts or socket inserts. However, if one side is a pin insert, the mating side should be a socket insert. The type to use will be determined by the state of the equipment but it is generally recommended to use the socket on the output side of the equipment and pin on the input side.

How to order

KD Order Reference

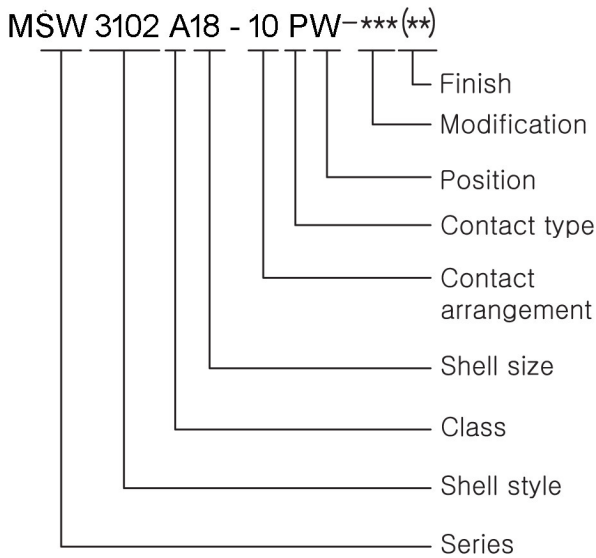

MS Order Reference

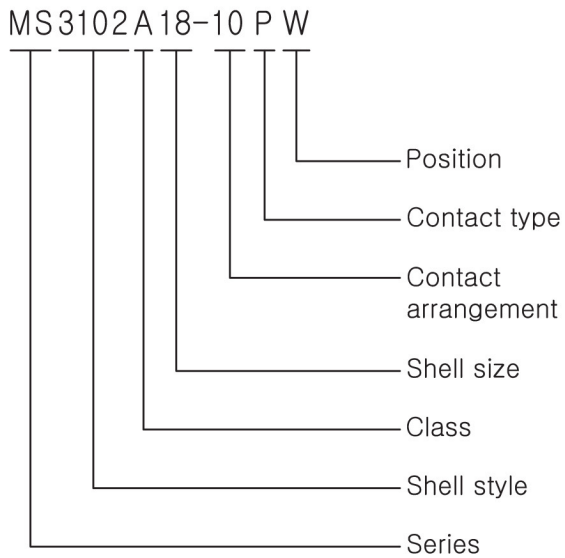

Series

- MSW MilSpecWest circular connectors with threaded coupling
- MS Military Standard to latest MIL-DTL-5015 revision

Shell style

- 3100 Wall mounting receptacle
- 3101 Cable connecting plug
- 3102 Box mounting receptacle
- 3106 Straight plug
- 3108 90° plug
- 25183 Potting seal plug

Class

- A Solid shell solder contact connectors.
- B Split shell solder contact connectors.
- E/F Environmental with resilient insulators and integral cable clamp.
- P Environment resistant potted solder contact connectors.
- R Environmental with resilient insulators and shortened lightweight endbell.

Shell size

- 10SL, 12s, 12, 14s, 16s, 16, 18
- 20, 22, 24, 28, 32, 36, 40

Contact arrangement

See page 7~19

Contact type

- P – Pin contact
- S – Socket contact

Position

Alternate insert position(W,X,Y or Z)
 Leave Blank for Normal position
 See page 7~9

Modification

- No code Threaded Coupling Nut (with Solder contacts)
- B Bayonet Coupling Nut (with Solder contacts)
- F80 Threaded Coupling Nut (with Crimp AWG contacts)
- B-F80 Bayonet Coupling Nut (with Crimp AWG contacts)

Finish

- No code Cadmium Olive Drab over Electroless Nickel
- 689 Electroless Nickel
- 623 Black Zinc Alloy
- Consult factory for other finishes.

Contact Arrangements [For Class A, E/F, P, R]

Alternate Insert Positions

※ View shows pin front side or socket rear side

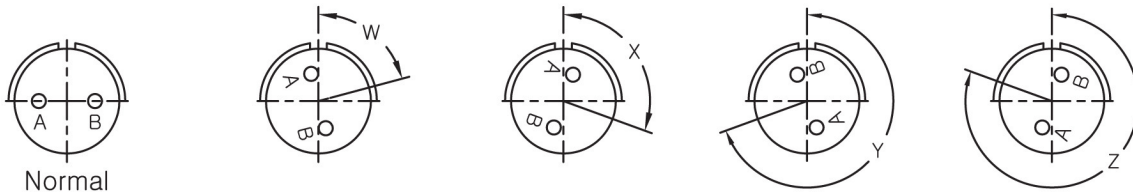

Shell Size	Insert Number	Contacts							Alternate pos.			
		Tot	20	16	12	8	4	0	W	X	Y	Z
10SL	10SL-3	3	3									
	10SL-4	2	2									
12s	12s-3	2	2					70	145	215	290	
	12s-4	1	1									
	12SA10	4	4									
12	12-5	1			1							
14s	14s-1	3	3									
	14s-2	4	4						120	240		
	14s-4	1	1									
	14s-5	5	5							110		
	14s-6	6	6									
	14s-7	3	3					90	180	270		
	14s-9	2	2					70	145	215	290	
	14SA7	7	7									
	14SA10	10	10									
14	14-3	1				1						
16s	16s-1	7	7					80			280	
	16s-4	2	2					35	110	250	325	
	16s-5	3	3					70	145	215	290	
	16s-8	5	5						170	265		
	16s-01	8	8									
16	16-9	4	2	2				35	110	250	325	
	16-10	3		3				90	180	270		
	16-11	2		2				35	110	250	325	
18	18-1	10	10					70	145	215	290	
	18-3	2		2				35	110	250	325	
	18-4	4	4					35	110	250	325	
	18-5	3	1	2				80	110	250	280	
	18-8	8	7	1				70			290	
	18-9	7	5	2				80	110	250	280	

Shell Size	Insert Number	Contacts							Alternate pos.			
		Tot	20	16	12	8	4	0	W	X	Y	Z
18	18-10	4			4					120	240	
	18-11	5			5					170	265	
	18-12	6		6				80			280	
	18-19	10		10					120	240		
	18-20	5		5				90	180	270		
	18-21	3			3							
	18-22	3		3				70	145	215	290	
	20	20-2	1						1			
20-3		3			3			70	145	215	290	
20-4		4			4			45	110	250		
20-7		8		8				80	110	250	280	
20-11		13		13								
20-15		7			7			80			280	
20-16		9		7	2			80	110	250	280	
20-17		6		1	5			90	180	270		
20-18		9		6	3			35	110	250	325	
20-19		3				3		90	180	270		
20-22		6		3		3		80	110	250	280	
20-23		2					2	35	110	250	325	
20-24		4		2		2		35	110	250	325	
20-27		14		14				35	110	250	325	
20-29		17		17				80			280	
20-33		11		11								
20-01	10		10									
20A24	24	24										
20A48	19	19						80	280			
22	22-1	2				2		35	110	250	325	
	22-2	3				3		70	145	215	290	
	22-5	6		4	2			35	110	250	325	
	22-7	1						1				

Contact Arrangements [For Class A, E/F, P, R]

Alternate Insert Positions

※ View shows pin front side or socket rear side

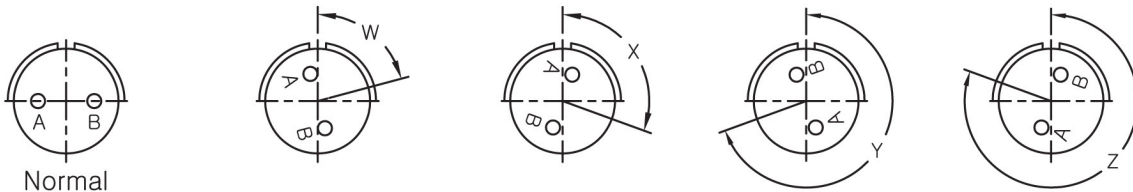

Shell Size	Insert Number	Contacts							Alternate pos.			
		Tot	20	16	12	8	4	0	W	X	Y	Z
22	22-8	2			2				35	110	250	325
	22-9	3			3				70	145	215	290
	22-10	4		4					35	110	250	325
	22-14	19		19					80	110	250	280
	22-19	14		14					80	110	250	280
	22-22	4					4			110	250	
	22-23	8			8				35		250	
24	24-2	7			7				80			280
	24-5	16		16					80	110	250	280
	24-7	16		14	2				80	110	250	280
	24-9	2					2		35	110	250	325
	24-10	7				7			80			280
	24-11	9			6	3			35	110	250	325
	24-12	5			3		2		80	110	250	280
	24-20	11		9	2				80	110	250	280
	24-21	10		9		1			80	110	250	280
	24-22	4				4			45	110	250	
	24-28	24		24					80	110	250	280
	24-67	19			19				80			335
	24B24	12			12							
	28	28-2	14		12	2				35	110	250
28-3		3				3			70	145	215	290
28-5		5		2	1		2		35	110	250	325
28-6		3					3		70	145	215	290
28-9		12		6	6				80	110	250	280
28-10		7			3	2	2		80	110	250	280
28-11		22		18	4				80	110	250	280
28-12		26		26					90	180	270	
28-15		35		35					80	110	250	280
28-16		20		20					80	110	250	280

Shell Size	Insert Number	Contacts							Alternate pos.				
		Tot	20	16	12	8	4	0	W	X	Y	Z	
28	28-17	15		15					80	110	250	280	
	28-19	10		6	4				80	110	250	280	
	28-20	14		4	10				80	110	250	280	
	28-21	37		37					80	110	250	280	
	28-22	6		3			3		70	145	215	290	
	28-51	12			12				80	135	195		
	28-72	72	72						72	144	216	288	
	28A16	9		5			4						
32	32-1	5			3			2	80	110	250	280	
	32-3	9		4	2		2	1	80	110	250	280	
	32-5	2						2	35	110	250	325	
	32-6	23		16	2	3	2		80	110	250	280	
	32-7	35		28	7				80	125	235	280	
	32-8	30		24	6				80	125	235	280	
	32-15	8			6			2	35	110	250	280	
	32-17	4						4	45	110	250		
	32-59	42		40		2							
	32-63	5						5					
	32-101	101	101						30	142			
	32A10	54		54									
	36	36-1	22		18	4				80	110	250	280
		36-3	6			3			3	70	145	215	290
36-4		3						3	70	145	215	290	
36-5		4						4		120	240		
36-8		47		46	1				80	110	250	280	
36-9		31		14	14	2	1		80	125	235	280	
36-10		48		48					80	125	235	280	
36-77		7						7					
36-78		14		2		12			35	106	254	325	
40		40-56	85		85					72	144	216	288

Contact Arrangements [For Class B] Alternate Insert Positions

* View shows pin front side or socket rear side

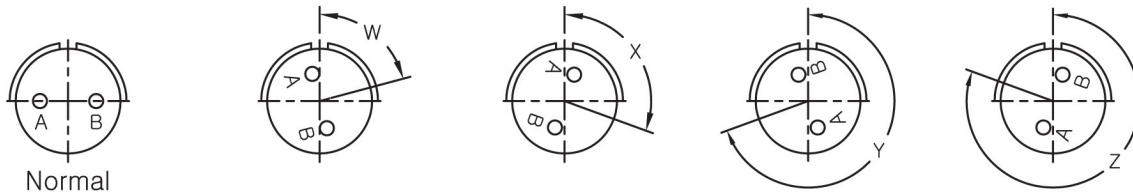

Shell Size	Insert Number	Contacts							Alternate pos.			
		Tot	20	16	12	8	4	0	W	X	Y	Z
14s	14s-2	4	4						120	240		
	14s-5	5	5						110			
	14s-6	6	6									
16	16-10	3		3				90	180	270		
18	18-1	10	10					70	145	215	290	
	18-8	8	7	1				70			290	
	18-10	4		4				120	240			
	18-12	6	6					80			280	
	18-19	10	10					120	240			
20	20-4	4		4				45	110	250		
	20-7	8	8					80	110	250	280	
	20-15	7		7				80			280	
	20-16	9	7	2				80	110	250	280	
	20-18	9	6	3				35	110	250	325	
	20-27	14	14					35	110	250	325	
	20-29	17	17					80			280	

Shell Size	Insert Number	Contacts							Alternate pos.			
		Tot	20	16	12	8	4	0	W	X	Y	Z
22	22-14	19		19					80	110	250	280
	22-19	14		14					80	110	250	280
	22-22	4				4			110	250		
	22-23	8			8				35		250	
24	24-2	7			7				80			280
	24-5	16		16					80	110	250	280
	24-10	7				7			80			280
	24-11	9			6	3			35	110	250	325
	24-28	24		24					80	110	250	280
28	28-2	14		12	2				35	110	250	325
	28-11	22		18	4				80	110	250	280
	28-15	35		35					80	110	250	280
	28-16	20		20					80	110	250	280
	28-20	14		4	10				80	110	250	280
	28-21	37		37					80	110	250	280
32	32-7	35		28	7				80	125	235	280
	32-17	4				4			45	110	250	
	32-22	54		54								
36	36-10	48		48					80	125	235	280

Contact Arrangements

Contact Size

20 ○ 16 ● 12 ⊕ 8 ⊗ 4 ⊕ 0 ⊕

1 CONTACT



Insert number	12S-4	12-5	14-3	14S-4
No. of contacts	1	1	1	1
Contact size	16	12	8	16
Service rating	D	D	A	D



Insert number	16-12	20-2	22-7
No. of contacts	1	1	1
Contact size	4	0	0
Service rating	A	D	E

2 CONTACT



Insert number	10SL-4	12S-3	14S-9	16S-4
No. of contacts	2	2	2	2
Contact size	16	16	16	16
Service rating	A	A	A	D

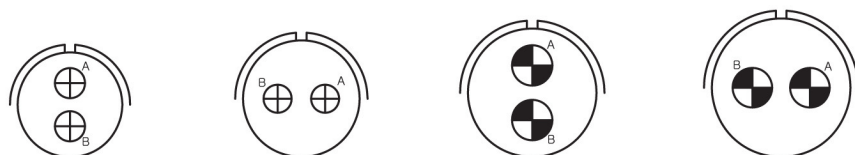

Insert number	16-11	18-3	20-23	22-1
No. of contacts	2	2	2	2
Contact size	12	12	8	8
Service rating	A	D	A	D

Contact Size

20 ○ 16 ● 12 ⊕ 8 ⊗ 4 ⊕ 0 ⊕

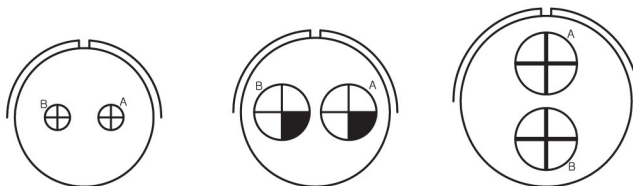

Insert number	22-8	24-9	32-5
No. of contacts	2	2	2
Contact size	12	4	0
Service rating	E	A	D

3 CONTACT



Insert number	10SL-3	14S-1	16S-5	16-10
No. of contacts	3	3	3	3
Contact size	16	MILSPECWEST, LLC	16	12
Service rating	A		A	A



Insert number	18-21	18-22	20-3	20-19
No. of contacts	3	3	3	3
Contact size	12	16	12	8
Service rating	A	D	D	A

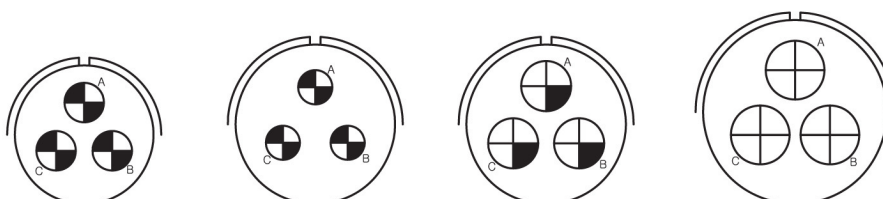

Insert number	22-2	28-3	28-6	36-4
No. of contacts	3	3	3	3
Contact size	8	8	4	0
Service rating	D	E	D	D(A) A(B,C)

Contact Size

20 ○ 16 ● 12 ⊕ 8 ⊗ 4 ⊕ 0 ⊕

4 CONTACT

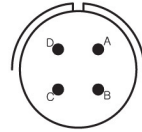
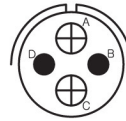
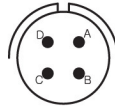
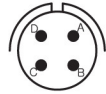

Insert number	12SA10	14S-2	16-9	18-4
No. of contacts	4	4	4	4
Contact size	16	16	2-16, 2-12	16
Service rating	INST	INST	A	D

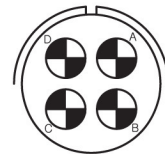
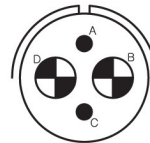
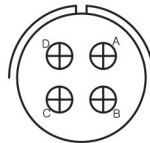
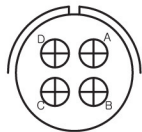

Insert number	18-10	20-4	20-24	22-22
No. of contacts	4	4	4	4
Contact size	12	12	2-16, 2-8	8
Service rating	A	D	A	A

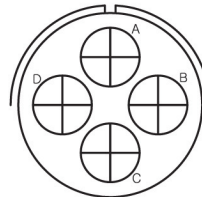
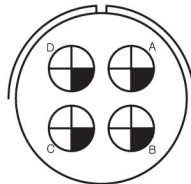
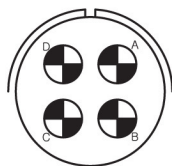

Insert number	24-22	32-17	36-5
No. of contacts	4	4	4
Contact size	8	4	0
Service rating	D	D	A

5 CONTACT

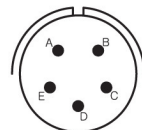
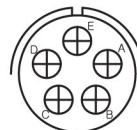
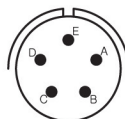
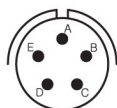

Insert number	14s-5	16s-8	18-11	18-20
No. of contacts	5	5	5	5
Contact size	16	16	12	16
Service rating	INST	A	A	A

Contact Size

20 ○ 16 ● 12 ⊕ 8 ⊕ 4 ⊕ 0 ⊕

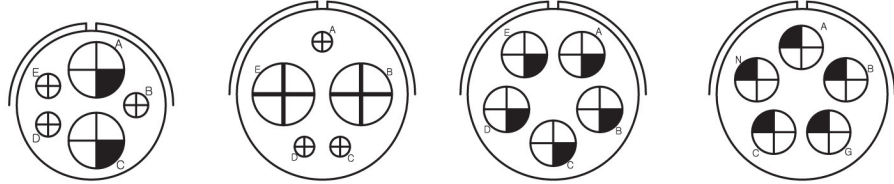

Insert number	24-12	32-1	32-63	32A5
No. of contacts	5	5	5	5
Contact size	3-12, 2-4	3-12, 2-0	4	4
Service rating	A	E(A) D(B,C,D,E)	D	D

6 CONTACT



Insert number	14S-6	18-12	20-8	20-17
No. of contacts	6	6	6	6
Contact size	16	16	4-16, 2-8	1-16, 5-12
Service rating	INST	A	INST	A

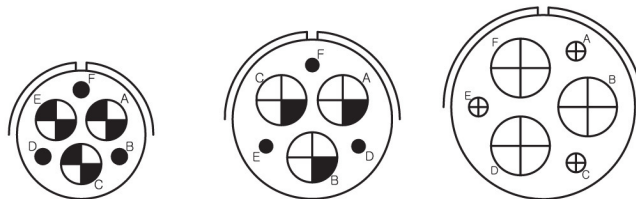

Insert number	20-22	28-22	36-3
No. of contacts	6	6	6
Contact size	3-16, 3-8	3-16, 3-4	12-3, 3-0
Service rating	A	D	D

7 CONTACT



Insert number	14SA7	16s-1	18-9	20-15
No. of contacts	7	7	7	7
Contact size	16	16	5-16, 2-12	12
Service rating	INST	A	INST	A

Contact Size

20 ○ 16 ● 12 ⊕ 8 ⊗ 4 ⊕ 0 ⊕

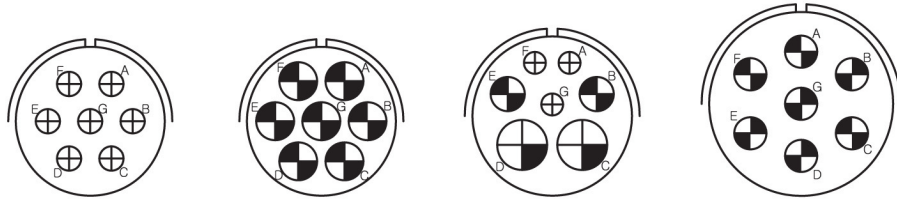

Insert number	24-2	24-10	28-10	36-77
No. of contacts	7	7	7	7
Contact size	12	8	3-12, 2-8, 2-4	4
Service rating	D	A	D(G) A(A,B,C,D,E,F)	D

8 CONTACT



Insert number	16s-01	18-8	20-7	22-18
No. of contacts	8	8	8	8
Contact size	16	7-16, 1-12	16	16
Service rating	A	A	D(A,B,G,H) A(All others)	D(All others) A(C,D,E)

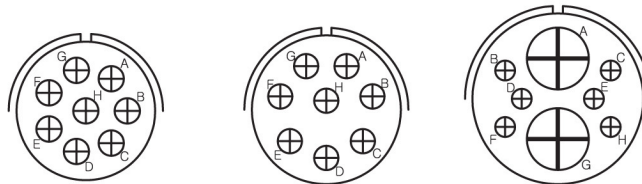

Insert number	22-23	24-6	32-15
No. of contacts	8	8	8
Contact size	12	12	6-12, 2-0
Service rating	D(H) A(All others)	D(A,G,H) A(All others)	D

9 CONTACT

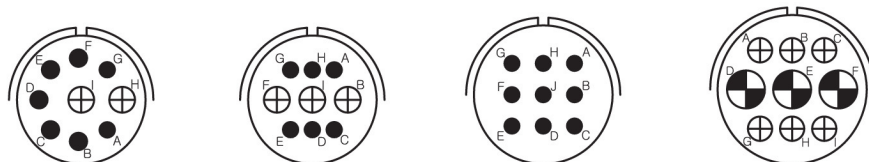

Insert number	20-16	20-18	22-20	24-11
No. of contacts	9	9	9	9
Contact size	7-16, 2-12	6-16, 3-12	16	6-12, 3-8
Service rating	A	A	A	A

Contact Size

20 ○ 16 ● 12 ⊕ 8 ⊕ 4 ⊕ 0 ⊕

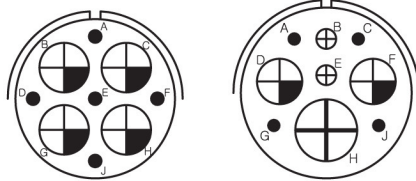

Insert number	28A16	32-3
No. of contacts	9	9
Contact size	5-16, 4-4	4-16, 2-12, 2-4, 1-0
Service rating	A(E) INST(All others)	

10 CONTACT

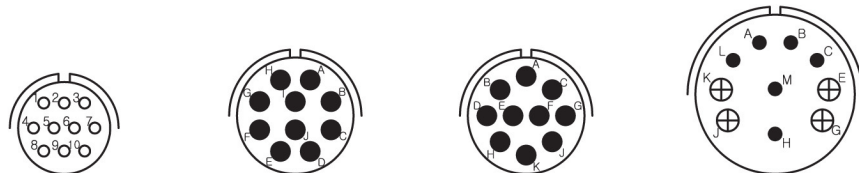

Insert number	14SA10	18-1	18-19	28-19
No. of contacts	10	10	10	10
Contact size	20	16	16	6-16, 4-12
Service rating	INST	A(B,C,F,G) INST(All others)	A	D(A,B) B(H,M) A(All others)

11 CONTACT

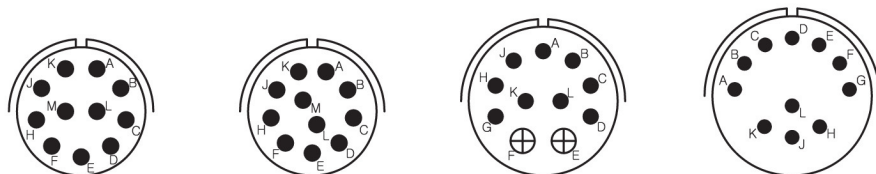

Insert number	20-31	20-33	24-20	28-14
No. of contacts	11	11	11	6
Contact size	16	16	9-16, 2-12	16
Service rating	A	A	D	D

12 CONTACT

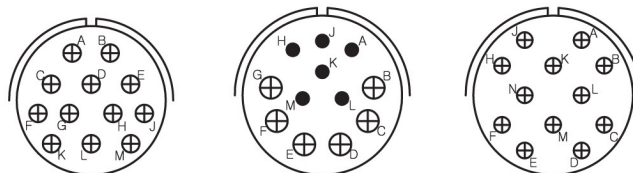

Insert number	24B24	28-9	28-51
No. of contacts	12	12	12
Contact size	12	6-16, 6-12	12
Service rating	A	D	D

Contact Size



13 CONTACT

14 CONTACT

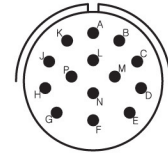
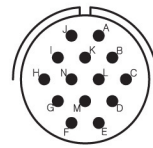
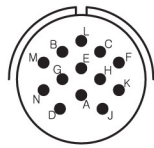

Insert number	20-11	20-27	22-19
No. of contacts	13	14	14
Contact size	16	16	16
Service rating	INST	A	A

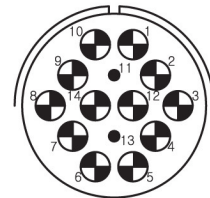
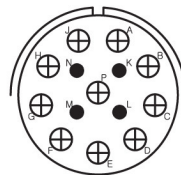
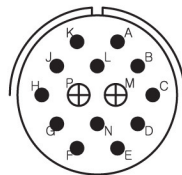

Insert number	28-2	28-20	36-78
No. of contacts	14	14	14
Contact size	12-16, 2-12	4-16, 10-12	2-16, 12-8
Service rating	D	A	D

15 CONTACT

16 CONTACT

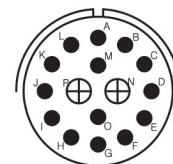
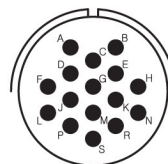
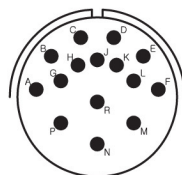

Insert number	28-17	24-5	24-7
No. of contacts	15	16	16
Contact size	16	16	14-16, 2-12
Service rating	B(R) D(M,N,P) A(All others)	A	A

Contact Size

20 ○ 16 ● 12 ⊕ 8 ⊕ 4 ⊕ 0 ⊕

17 CONTACT

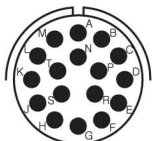

19 CONTACT

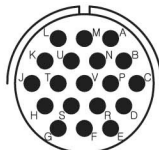

20 CONTACT

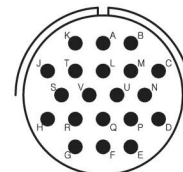

Insert number	20-29	22-14	28-16
No. of contacts	17	19	20
Contact size	16	16	16
Service rating	A	A	A

22 CONTACT

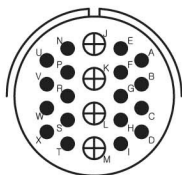

23 CONTACT

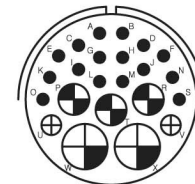
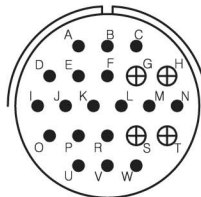

Insert number	28-11	36-1	32-6
No. of contacts	22	22	23
Contact size	18-16, 4-12	18-16, 4-12	16-16, 2-12, 3-8, 2-4
Service rating	A	D	A

24 CONTACT

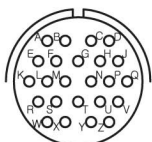

26 CONTACT

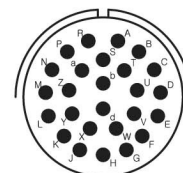
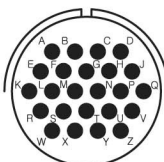

Insert number	20A24	24-28	28-12
No. of contacts	24	24	26
Contact size	20	16	16
Service rating	INST	INST	A

5015 STYLE SERIES

MilSpecWest

Contact Size

20 ○ 16 ● 12 ⊕ 8 ⊕ 4 ⊕ 0 ⊕

28 CONTACT

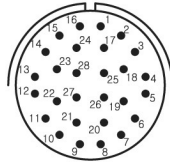

Insert number	24A28	32-8	36-9
No. of contacts	28	30	31
Contact size	16	24-16, 6-12	14-16, 14-12, 2-8, 1-4
Service rating	INST	A	A

30 CONTACT

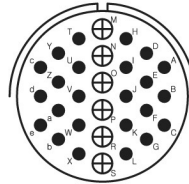

31 CONTACT

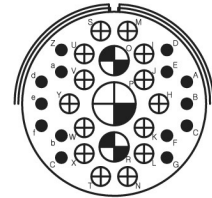

35 CONTACT

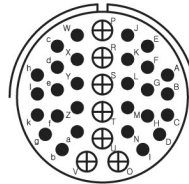
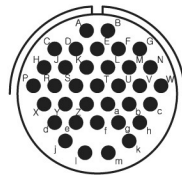

37 CONTACT

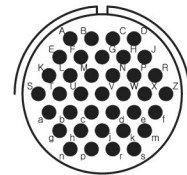

Insert number	28-15	32-7	28-21
No. of contacts	35	35	37
Contact size	16	28-16, 7-12	16
Service rating	A	A(all others) INST(A,B,h,j)	A

43 CONTACT

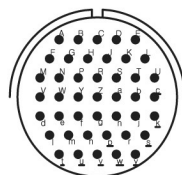

46 CONTACT

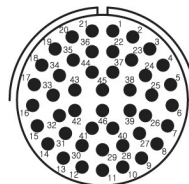

47 CONTACT

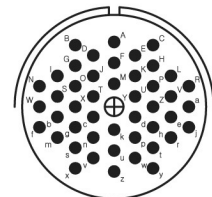

Insert number	28A51	32-73	36-8
No. of contacts	43	46	47
Contact size	16	16	46-16, 1-12
Service rating	A	A	A

Contact Size

20 ○ 16 ● 12 ⊕ 8 ⊕ 4 ⊕ 0 ⊕

48 CONTACT

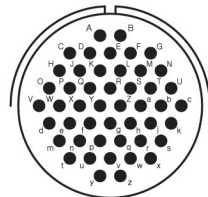

52 CONTACT

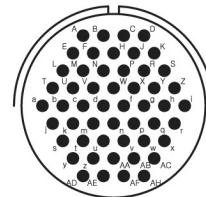

Insert number	36-10	36-52
No. of contacts	48	52
Contact size	16	16
Service rating	A	A

54 CONTACT

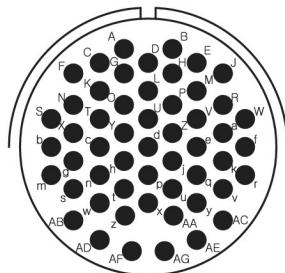

72 CONTACT

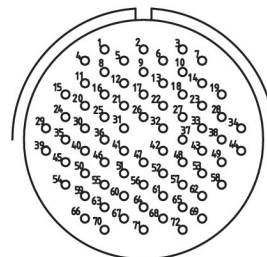

Insert number	32A10 & 32-22	28-72
No. of contacts	54	72
Contact size	16	20
Service rating	A	INST

85 CONTACT

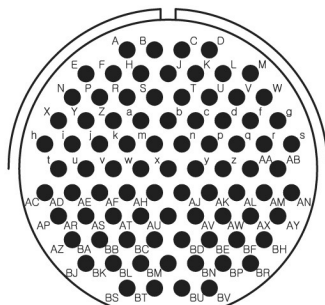

101 CONTACT

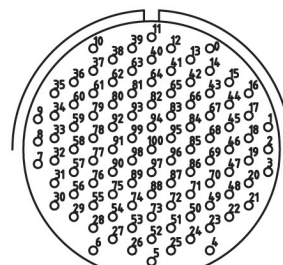

Insert number	40-56	32-101
No. of contacts	16	101
Contact size	85	20
Service rating	A	INST

Connector Dimensions

MSW3100 Class A
Wall mounting receptacle

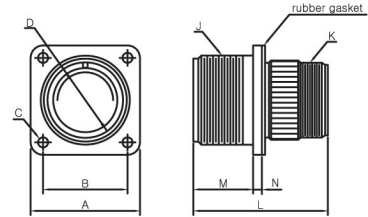

Shell size	□A	□B	∅C	∅D	J	K	L	M	N	
	±0.79	±0.13	+0.25 -0.13	+0.38	THD-2A	THD-2A	max	+0.79	max	min
10s / 10SL	25.40	18.26	3.05	11.38	5/8-24UNEF	5/8-24UNEF	38.89	14.27	3.96	1.57
12s	27.79	20.62	3.05	14.15	3/4-20UNEF	5/8-24UNEF	42.88	14.27	3.96	1.57
12	27.79	20.62	3.05	14.15	3/4-20UNEF	5/8-24UNEF	52.37	19.05	3.96	1.57
14s	30.18	23.01	3.05	17.32	7/8-20UNEF	3/4-20UNEF	42.88	14.27	3.96	1.57
14	30.18	23.01	3.05	17.32	7/8-20UNEF	3/4-20UNEF	52.37	19.05	3.96	1.57
16s	32.54	24.61	3.05	20.50	1 -20UNEF	7/8-20UNEF	42.88	14.27	3.96	1.57
16	32.54	24.61	3.05	20.50	1 -20UNEF	7/8-20UNEF	52.37	19.05	3.96	1.57
18	34.93	26.97	3.05	23.67	1 1/8-18UNEF	1 -20UNEF	52.37	19.05	5.16	2.39
20	38.10	29.36	3.05	26.87	1 1/4-18UNEF	1 3/16-18UNEF	55.58	19.05	5.16	2.39
22	41.28	31.75	3.05	30.02	1 3/8-18UNEF	1 3/16-18UNEF	55.58	19.05	5.16	2.39
24	44.45	34.93	3.73	33.20	1 1/2-18UNEF	1 7/16-18UNEF	58.72	20.62	5.16	2.39
28	50.80	39.67	3.73	38.76	1 3/4-18UNS	1 7/16-18UNEF	58.72	20.62	5.16	2.39
32	57.15	44.45	4.39	45.11	2 -18UNS	1 3/4-18UNS	61.93	22.23	9.12	3.18
36	63.50	49.23	4.39	50.67	2 1/4-16UN	2 -18UNS	61.93	22.23	9.12	3.18
40	69.85	55.58	4.39	57.02	2 1/2-16UN	2 1/4-16UN	61.93	22.23	9.12	3.18

MSW3100 Class E, F
Wall mounting receptacle
with integral cable clamp
(grommet included)

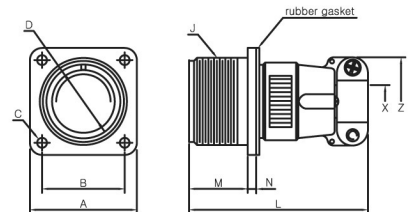

Used to carry wire thru walls
or bulkheads or to provide
a means of disconnection at a bulkhead

Shell size	□A	□B	∅C	∅D	J	L	M	N		X	Z
	±0.79	±0.13	+0.25 -0.13	+0.38	THD-2A	max	+0.79	max	min	min	±0.79
10s / 10SL	25.40	18.26	3.05	11.38	5/8-24UNEF	57.15	14.27	3.96	1.98	7.14	22.23
12s	27.79	20.62	3.05	14.15	3/4-20UNEF	57.15	14.27	3.96	1.98	7.14	22.23
12	27.79	20.62	3.05	14.15	3/4-20UNEF	66.68	19.05	3.96	1.98	7.14	22.23
14s	30.18	23.01	3.05	17.32	7/8-20UNEF	57.15	14.27	3.96	1.98	10.31	26.97
14	30.18	23.01	3.05	17.32	7/8-20UNEF	66.68	19.05	3.96	1.98	10.31	26.97
16s	32.54	24.61	3.05	20.50	1 -20UNEF	57.15	14.27	3.96	1.98	12.70	29.36
16	32.54	24.61	3.05	20.50	1 -20UNEF	66.68	19.05	3.96	1.98	12.70	29.36
18	34.93	26.97	3.05	23.67	1 1/8-18UNEF	68.28	19.05	5.16	2.39	13.49	31.75
20	38.10	29.36	3.05	26.87	1 1/4-18UNEF	69.85	19.05	5.16	2.39	16.66	37.31
22	41.28	31.75	3.05	30.02	1 3/8-18UNEF	69.85	19.05	5.16	2.39	19.05	37.31
24	44.45	34.93	3.73	33.20	1 1/2-18UNEF	75.41	20.62	5.16	2.39	19.84	42.88
28	50.80	39.67	3.73	38.76	1 3/4-18UNS	76.99	20.62	5.16	2.39	23.42	42.88
32	57.15	44.45	4.39	45.11	2 -18UNS	76.99	22.23	9.12	3.18	29.36	51.59
36	63.50	49.23	4.39	50.67	2 1/4-16UN	83.34	22.23	9.12	3.18	31.75	57.94

Connector Dimensions

MSW3100, Class r

Wall mounting receptacle
(grommet included)

R type has a shorter and
lightweight endbell than E, F type

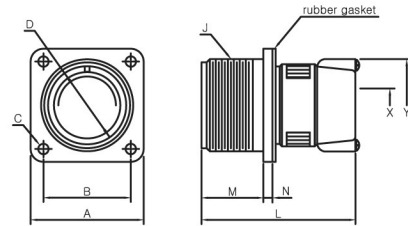

Shell size	□A	□B	φC	φD	J	L	M	N		X	Y
	±0.79	±0.13	+0.25 -0.13	+0.38	THD-2A	max	+0.79	max	min	min	±0.25
10s/10SL	25.40	18.26	3.05	11.38	5/8-24UNEF	46.69	14.27	3.96	1.98	7.14	23.83
12s	27.79	20.62	3.05	14.15	3/4-20UNEF	46.69	14.27	3.96	1.98	7.14	23.83
12	27.79	20.62	3.05	14.15	3/4-20UNEF	55.40	19.05	3.96	1.98	7.14	23.83
14s	30.18	23.01	3.05	17.32	7/8-20UNEF	46.69	14.27	3.96	1.98	10.31	28.58
14	30.18	23.01	3.05	17.32	7/8-20UNEF	55.40	19.05	3.96	1.98	10.31	28.58
16s	32.54	24.61	3.05	20.50	1 -20UNEF	46.69	14.27	3.96	1.98	12.70	30.96
16	32.54	24.61	3.05	20.50	1 -20UNEF	55.40	19.05	3.96	1.98	12.70	30.96
18	34.93	26.97	3.05	23.67	1 1/8-18UNEF	57.94	19.05	5.16	2.39	13.49	35.71
20	38.10	29.36	3.05	26.87	1 1/4-18UNEF	57.94	19.05	5.16	2.39	16.66	38.10
22	41.28	31.75	3.05	30.02	1 3/8-18UNEF	57.94	19.05	5.16	2.39	19.05	39.67
24	44.45	34.93	3.73	33.20	1 1/2-18UNEF	57.94	20.62	5.16	2.39	19.84	46.84
28	50.80	39.67	3.73	38.76	1 3/4-18UNS	57.94	20.62	5.16	2.39	23.42	46.84
32	57.15	44.45	4.39	45.11	2 -18UNS	58.98	22.23	9.12	3.18	29.36	53.98
36	63.50	49.23	4.39	50.67	2 1/4-16UN	58.98	22.23	9.12	3.18	31.75	58.72

MSW3102, Class A

Box mounting receptacle

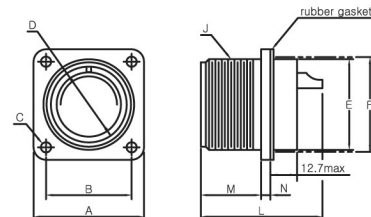

Shell size	□A	□B	φC	φD	φE	φF	J	L	M	N	
	±0.79	±0.13	+0.25 -0.13	+0.38	-4.78	Mounting Hole max	THD-2A	max	+0.79	max	min
10s/10SL	25.40	18.26	3.05	11.38	19.86	20.62	5/8-24UNEF	30.25	14.27	3.96	1.98
12s	27.79	20.62	3.05	14.15	19.86	20.62	3/4-20UNEF	30.25	14.27	3.96	1.98
12	27.79	20.62	3.05	14.15	19.86	20.62	3/4-20UNEF	43.51	19.05	3.96	1.98
14s	30.18	23.01	3.05	17.32	23.01	23.83	7/8-20UNEF	30.25	14.27	3.96	1.98
14	30.18	23.01	3.05	17.32	23.01	23.83	7/8-20UNEF	43.51	19.05	3.96	1.98
16s	32.54	24.61	3.05	20.50	26.21	26.97	1 -20UNEF	30.25	14.27	3.96	1.98
16	32.54	24.61	3.05	20.50	26.21	26.97	1 -20UNEF	44.45	19.05	3.96	1.98
18	34.93	26.97	3.05	23.67	29.36	30.18	1 1/8-18UNEF	49.23	19.05	5.16	2.39
20	38.10	29.36	3.05	26.87	32.56	33.32	1 1/4-18UNEF	49.23	19.05	5.16	2.39
22	41.28	31.75	3.05	30.02	35.71	36.53	1 3/8-18UNEF	49.23	19.05	5.16	2.39
24	44.45	34.93	3.73	33.20	38.91	39.97	1 1/2-18UNEF	49.23	20.62	5.16	2.39
28	50.80	39.67	3.73	38.76	45.26	46.02	1 3/4-18UNS	49.23	20.62	5.16	2.39
32	57.15	44.45	4.39	45.11	51.61	52.37	2 -18UNS	49.23	22.23	9.12	3.18
36	63.50	49.23	4.39	50.67	57.96	58.72	2 1/4-16UN	49.23	22.23	9.12	3.18
40	69.85	55.58	4.39	57.02	64.31	65.07	2 1/2-16UN	49.23	22.23	9.12	3.18

Connector Dimensions

MSW3102, Class R
Box mounting receptacle

Used in junction boxes or as an integral part of equipment

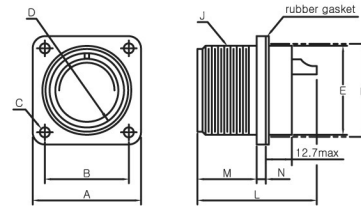

Shell size	□A	□B	∅C	∅D	∅E	∅F	J	L	M	N	
	±0.79	±0.13	+0.25 -0.13	+0.38	-4.78	Mounting Hole max				THD-2A	max
10s/10SL	25.40	18.26	3.05	11.38	19.86	20.62	5/8-24UNEF	30.18	14.27	3.96	1.98
12s	27.79	20.62	3.05	14.15	19.86	20.62	3/4-20UNEF	30.18	14.27	3.96	1.98
12	27.79	20.62	3.05	14.15	19.86	20.62	3/4-20UNEF	41.28	19.05	3.96	1.98
14s	30.18	23.01	3.05	17.32	23.01	23.83	7/8-20UNEF	30.18	14.27	3.96	1.98
14	30.18	23.01	3.05	17.32	23.01	23.83	7/8-20UNEF	41.28	19.05	3.96	1.98
16s	32.54	24.61	3.05	20.50	26.21	26.97	1 -20UNEF	30.18	14.27	3.96	1.98
16	32.54	24.61	3.05	20.50	26.21	26.97	1 -20UNEF	41.28	19.05	3.96	1.98
18	34.93	26.97	3.05	23.67	29.36	30.18	1 1/8-18UNEF	49.23	19.05	5.16	2.39
20	38.10	29.36	3.05	26.87	32.56	33.32	1 1/4-18UNEF	49.23	19.05	5.16	2.39
22	41.28	31.75	3.05	30.02	35.71	36.53	1 3/8-18UNEF	49.23	19.05	5.16	2.39
24	44.45	34.93	3.73	33.20	38.91	39.97	1 1/2-18UNEF	49.23	20.62	5.16	2.39
28	50.80	39.67	3.73	38.76	45.26	46.02	1 3/4-18UNS	49.23	20.62	5.16	2.39
32	57.15	44.45	4.39	45.11	51.61	52.37	2 -18UNS	49.23	22.23	9.12	3.18
36	63.50	49.23	4.39	50.67	57.96	58.72	2 1/4-16UN	49.23	22.23	9.12	3.18

MSW3101, Class A
Cable connecting plug

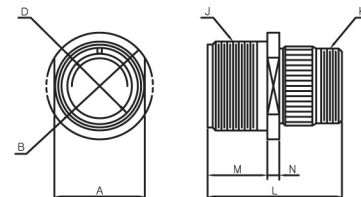

Shell size	A	∅B	∅D	J	K	L	M	N	
	max	max	+0.38	THD-2A	THD-2A	max	+0.79	max	min
10s/10SL	16.26	24.61	11.38	5/8-24UNEF	5/8-24UNEF	38.89	14.27	3.96	1.98
12s	19.43	26.97	14.15	3/4-20UNEF	5/8-24UNEF	42.88	14.27	3.96	1.98
12	19.43	26.97	14.15	3/4-20UNEF	5/8-24UNEF	52.37	19.05	3.96	1.98
14s	22.61	29.36	17.32	7/8-20UNEF	3/4-20UNEF	42.88	14.27	3.96	1.98
14	22.61	29.36	17.32	7/8-20UNEF	3/4-20UNEF	52.37	19.05	3.96	1.98
16s	25.78	31.75	20.50	1 -20UNEF	7/8-20UNEF	42.88	14.27	3.96	1.98
16	25.78	31.75	20.50	1 -20UNEF	7/8-20UNEF	52.37	19.05	3.96	1.98
18	28.96	34.14	23.67	1 1/8-18UNEF	1 -20UNEF	52.37	19.05	5.16	2.39
20	32.13	37.31	26.87	1 1/4-18UNEF	1 3/16-18UNEF	55.58	19.05	5.16	2.39
22	35.31	40.49	30.02	1 3/8-18UNEF	1 3/16-18UNEF	55.58	19.05	5.16	2.39
24	38.48	43.66	33.20	1 1/2-18UNEF	1 7/16-18UNEF	58.72	20.62	5.16	2.39
28	44.83	50.01	38.76	1 3/4-18UNS	1 7/16-18UNEF	58.72	20.62	5.16	2.39
32	51.18	56.36	45.11	2 -18UNS	1 3/4-18UNS	61.93	22.23	9.12	3.18
36	57.53	62.71	50.67	2 1/4-16UN	2 -18UNS	61.93	22.23	9.12	3.18
40	63.88	69.06	57.02	2 1/2-16UN	2 1/4-18UN	61.93	22.23	9.12	3.18

Connector Dimensions

MSW3101, Class E, F
Cable connecting plug
(grommet included)

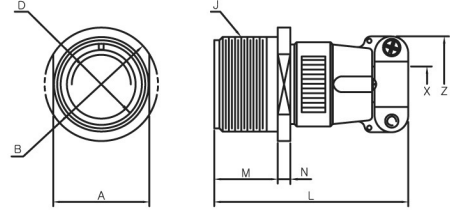

Used for cable extension requirements,
where mounting provisions are unnecessary

Shell size	A max	φB max	φD +0.38	J THD-2A	L max	M +0.79	N		X min	Z ±0.79
							max	min		
10s/10SL	16.26	26.97	11.38	5/8-24UNEF	57.15	14.27	3.96	1.57	7.14	22.23
12s	19.43	26.97	14.15	3/4-20UNEF	57.15	14.27	3.96	1.57	7.14	22.23
12	19.43	26.97	14.15	3/4-20UNEF	66.68	19.05	3.96	1.57	7.14	22.23
14s	22.61	29.36	17.32	7/8-20UNEF	57.15	14.27	3.96	1.57	10.31	26.97
14	22.61	29.36	17.32	7/8-20UNEF	66.68	19.05	3.96	1.57	10.31	26.97
16s	25.78	32.54	20.50	1 -20UNEF	57.15	14.27	3.96	1.57	12.70	29.36
16	25.78	32.54	20.50	1 -20UNEF	66.68	19.05	3.96	1.57	12.70	29.36
18	28.96	34.14	23.67	1 1/8-18UNEF	68.28	19.05	5.16	2.39	13.49	31.75
20	32.13	38.10	26.87	1 1/4-18UNEF	69.85	19.05	5.16	2.39	16.66	37.31
22	35.31	41.28	30.02	1 3/8-18UNEF	69.85	19.05	5.16	2.39	19.05	37.31
24	38.48	44.45	33.20	1 1/2-18UNEF	75.41	20.62	5.16	2.39	19.84	42.88
28	44.83	50.80	38.76	1 3/4-18UNS	76.99	20.62	5.16	2.39	23.42	42.88
32	51.18	57.15	45.11	2 -18UNS	76.99	22.23	9.12	3.18	29.36	51.59
36	57.53	63.50	50.67	2 1/4-16UN	83.34	22.23	9.12	3.18	31.75	57.94

MSW3101, Class R
Cable connecting plug
(grommet included)

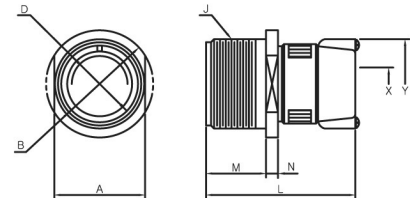

R type has a shorter and lightweight
endbell than E, F type

Shell size	A max	φB max	φD +0.38	J THD-2A	L max	M +0.79	N		X min	Y ±0.25
							max	min		
10s/10SL	16.26	26.97	11.38	5/8-24UNEF	46.69	14.27	3.96	1.57	7.14	23.83
12s	19.43	26.97	14.15	3/4-20UNEF	46.69	14.27	3.96	1.57	7.14	23.83
12	19.43	26.97	14.15	3/4-20UNEF	55.40	19.05	3.96	1.57	7.14	23.83
14s	22.61	29.36	17.32	7/8-20UNEF	46.69	14.27	3.96	1.57	10.31	28.58
14	22.61	29.36	17.32	7/8-20UNEF	55.40	19.05	3.96	1.57	10.31	28.58
16s	25.78	32.54	20.50	1 -20UNEF	46.69	14.27	3.96	1.57	12.70	30.96
16	25.78	32.54	20.50	1 -20UNEF	55.40	19.05	3.96	1.57	12.70	30.96
18	28.96	34.14	23.67	1 1/8-18UNEF	57.94	19.05	5.16	2.39	13.49	35.71
20	32.13	38.10	26.87	1 1/4-18UNEF	57.94	19.05	5.16	2.39	16.66	38.10
22	35.31	41.28	30.02	1 3/8-18UNEF	57.94	19.05	5.16	2.39	19.05	39.67
24	38.48	44.45	33.20	1 1/2-18UNEF	57.94	20.62	5.16	2.39	19.84	46.84
28	44.83	50.80	38.76	1 3/4-18UNS	57.94	20.62	5.16	2.39	23.42	46.84
32	51.18	57.15	45.11	2 -18UNS	58.98	22.23	9.12	3.18	29.36	53.98
36	57.53	63.50	50.67	2 1/4-16UN	58.98	22.23	9.12	3.18	31.75	58.72

Connector Dimensions

MSW3106, Class A
Straight plug

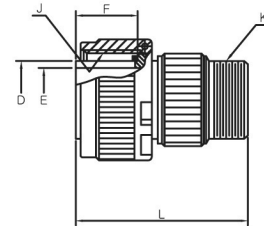
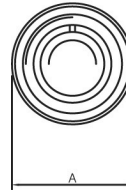

Shell size	ϕA max	ϕD -0.38	ϕE min	F ± 0.13	J THD-2B	K THD-2A	L max
10s/10SL	24.61	11.33	10.20	13.49	5/8-24UNEF	5/8-24UNEF	38.89
12s	26.97	14.10	11.43	13.49	3/4-20UNEF	5/8-24UNEF	42.88
12	26.97	14.10	11.43	18.26	3/4-20UNEF	5/8-24UNEF	52.37
14s	29.36	17.15	13.36	13.49	7/8-20UNEF	3/4-20UNEF	42.88
14	29.36	17.15	13.36	18.26	7/8-20UNEF	3/4-20UNEF	52.37
16s	31.75	20.45	16.54	13.49	1 -20UNEF	7/8-20UNEF	42.88
16	31.75	20.45	16.54	18.26	1 -20UNEF	7/8-20UNEF	52.37
18	34.14	23.62	19.71	18.26	1 1/8-18UNEF	1 -20UNEF	52.37
20	37.31	26.67	23.67	18.26	1 1/4-18UNEF	1 3/16-18UNEF	55.58
22	40.49	29.85	26.06	18.26	1 3/8-18UNEF	1 3/16-18UNEF	55.58
24	43.66	33.02	29.24	18.26	1 1/2-18UNEF	1 7/16-18UNEF	58.72
28	50.01	38.61	34.80	18.26	1 3/4-18UNS	1 7/16-18UNEF	58.72
32	56.36	44.96	41.15	18.26	2 -18UNS	1 3/4-18UNS	61.93
36	62.71	50.29	46.69	18.26	2 1/4-16UN	2 -18UNS	61.93
40	69.06	56.64	52.25	18.26	2 1/2-16UN	2 1/4-18UN	61.93

MSW3106, Class E, F
Straight plug with integral
cable clamp and grommet

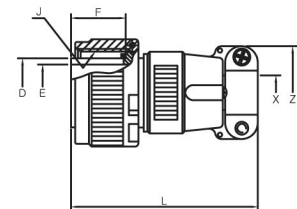

Shell size	ϕA max	ϕD -0.38	ϕE min	F ± 0.13	J THD-2B	L max	X min	Z ± 0.79
10s/10SL	24.61	11.33	10.20	13.49	5/8-24UNEF	57.15	7.14	22.23
12s	26.97	14.10	11.43	13.49	3/4-20UNEF	57.15	7.14	22.23
12	26.97	14.10	11.43	18.26	3/4-20UNEF	66.68	7.14	22.23
14s	29.36	17.15	13.36	13.49	7/8-20UNEF	57.15	10.31	26.97
14	29.36	17.15	13.36	18.26	7/8-20UNEF	66.68	10.31	26.97
16s	31.75	20.45	16.54	13.49	1 -20UNEF	57.15	12.70	29.36
16	31.75	20.45	16.54	18.26	1 -20UNEF	66.68	12.70	29.36
18	34.14	23.62	19.71	18.26	1 1/8-18UNEF	68.28	13.49	31.75
20	37.31	26.67	23.67	18.26	1 1/4-18UNEF	69.85	16.66	37.31
22	40.49	29.85	26.06	18.26	1 3/8-18UNEF	69.85	19.05	37.31
24	43.66	33.02	29.24	18.26	1 1/2-18UNEF	75.41	19.84	42.88
28	50.01	38.61	34.80	18.26	1 3/4-18UNS	76.99	23.42	42.88
32	56.36	44.96	41.15	18.26	2 -18UNS	76.99	29.36	51.59
36	62.71	50.29	46.69	18.26	2 1/4-16UN	83.34	31.75	57.94

Connector Dimensions

MSW3106, Class R
Straight plug with grommet
Identical in purpose to the
MSW3106, Class F

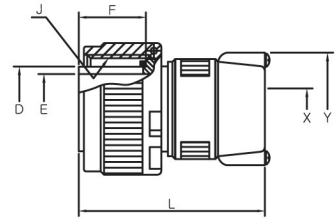
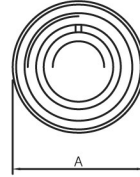

Shell size	ϕA max	ϕD -0.38	ϕE min	F ± 0.13	J THD-2B	L max	X min	Y ± 0.25
10s/10SL	24.61	11.33	10.20	13.49	5/8-24UNEF	46.69	7.14	23.83
12s	26.97	14.10	11.43	13.49	3/4-20UNEF	46.69	7.14	23.83
12	26.97	14.10	11.43	18.26	3/4-20UNEF	55.40	7.14	23.83
14s	29.36	17.15	13.36	13.49	7/8-20UNEF	46.69	10.31	28.58
14	29.36	17.15	13.36	18.26	7/8-20UNEF	55.40	10.31	28.58
16s	31.75	20.45	16.54	13.49	1 -20UNEF	46.69	12.70	30.96
16	31.75	20.45	16.54	18.26	1 -20UNEF	55.40	12.70	30.96
18	34.14	23.62	19.71	18.26	1 1/8-18UNEF	57.94	13.49	35.71
20	37.31	26.67	23.67	18.26	1 1/4-18UNEF	57.94	16.66	38.10
22	40.49	29.85	26.06	18.26	1 3/8-18UNEF	57.94	19.05	39.67
24	43.66	33.02	29.24	18.26	1 1/2-18UNEF	57.94	19.84	46.84
28	50.01	38.61	34.80	18.26	1 3/4-18UNS	57.94	23.42	46.84
32	56.36	44.96	41.15	18.26	2 -18UNS	58.98	29.36	53.98
36	62.71	50.29	46.69	18.26	2 1/4-16UN	58.98	31.75	58.72

MSW3108A, Class A
90° Angle plug

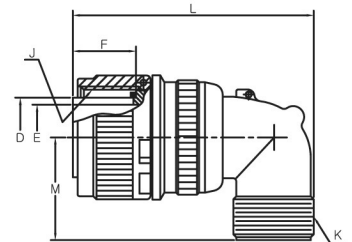
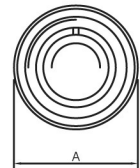

Shell size	ϕA max	ϕD -0.38	ϕE min	F ± 0.13	J THD-2B	K THD-2A	L max	M max
10s/10SL	24.61	11.33	10.20	13.49	5/8-24UNEF	5/8-24UNEF	46.02	25.40
12s	26.97	14.10	11.43	13.49	3/4-20UNEF	5/8-24UNEF	50.80	26.97
12	26.97	14.10	11.43	18.26	3/4-20UNEF	5/8-24UNEF	57.15	26.97
14s	29.36	17.15	13.36	13.49	7/8-20UNEF	3/4-20UNEF	53.98	28.58
14	29.36	17.15	13.36	18.26	7/8-20UNEF	3/4-20UNEF	58.72	28.58
16s	31.75	20.45	16.54	13.49	1 -20UNEF	7/8-20UNEF	60.33	30.18
16	31.75	20.45	16.54	18.26	1 -20UNEF	7/8-20UNEF	65.07	30.18
18	34.14	23.62	19.71	18.26	1 1/8-18UNEF	1 -20UNEF	68.28	33.32
20	37.31	26.67	23.67	18.26	1 1/4-18UNEF	1 3/16-18UNEF	76.99	34.93
22	40.49	29.85	26.06	18.26	1 3/8-18UNEF	1 3/16-18UNEF	76.99	34.93
24	43.66	33.02	29.24	18.26	1 1/2-18UNEF	1 7/16-18UNEF	86.51	39.67
28	50.01	38.61	34.80	18.26	1 3/4-18UNS	1 7/16-18UNEF	86.51	39.67
32	56.36	44.96	41.15	18.26	2 -18UNS	1 3/4-18UNS	95.25	47.63
36	62.71	50.29	46.69	18.26	2 1/4-16UN	2 -18UNS	100.03	52.37

Connector Dimensions

MSW3108, Class E, R
90° Angle plug
(grommet included)

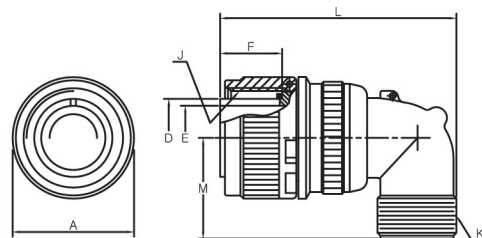

Shell size	ϕA	ϕD	ϕE	F	J	K	L	M
	max	-0.38	min	± 0.13	THD-2B	THD-2A	max	max
10s/10SL	24.61	11.33	10.20	13.49	5/8-24UNEF	5/8-24UNEF	46.02	25.40
12s	26.97	14.10	11.43	13.49	3/4-20UNEF	5/8-24UNEF	50.80	26.97
12	26.97	14.10	11.43	18.26	3/4-20UNEF	5/8-24UNEF	57.15	26.97
14s	29.36	17.15	13.36	13.49	7/8-20UNEF	3/4-20UNEF	53.98	28.58
14	29.36	17.15	13.36	18.26	7/8-20UNEF	3/4-20UNEF	58.72	28.58
16s	31.75	20.45	16.54	13.49	1 -20UNEF	7/8-20UNEF	60.33	30.18
16	31.75	20.45	16.54	18.26	1 -20UNEF	7/8-20UNEF	65.07	30.18
18	34.14	23.62	19.71	18.26	1 1/8-18UNEF	1 -20UNEF	68.28	33.32
20	37.31	26.67	23.67	18.26	1 1/4-18UNEF	1 3/16-18UNEF	76.99	34.93
22	40.49	29.85	26.06	18.26	1 3/8-18UNEF	1 3/16-18UNEF	76.99	34.93
24	43.66	33.02	29.24	18.26	1 1/2-18UNEF	1 7/16-18UNEF	86.51	39.67
28	50.01	38.61	34.80	18.26	1 3/4-18UNS	1 7/16-18UNEF	86.51	39.67
32	56.36	44.96	41.15	18.26	2 -18UNS	1 3/4-18UNS	95.25	47.63
36	62.71	50.29	46.69	18.26	2 1/4-16UN	2 -18UNS	100.03	52.37

MSW3108, Class F
90° Angle plug with
M85049/41 cable clamp
and grommet

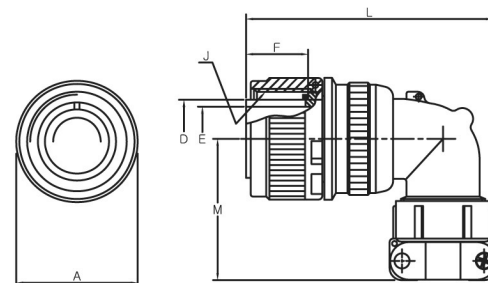

Shell size	ϕA	ϕD	ϕE	F	J	L	M
	max	-0.38	min	± 0.13	THD-2B	max	max
10s/10SL	24.61	11.33	10.20	13.49	5/8-24UNEF	55.58	38.10
12s	26.97	14.10	11.43	13.49	3/4-20UNEF	55.58	38.10
12	26.97	14.10	11.43	18.26	3/4-20UNEF	64.29	38.10
14s	29.36	17.15	13.36	13.49	7/8-20UNEF	58.72	40.49
14	29.36	17.15	13.36	18.26	7/8-20UNEF	68.28	40.49
16s	31.75	20.45	16.54	13.49	1 -20UNEF	61.11	42.88
16	31.75	20.45	16.54	18.26	1 -20UNEF	70.64	42.88
18	34.14	23.62	19.71	18.26	1 1/8-18UNEF	72.24	45.24
20	37.31	26.67	23.67	18.26	1 1/4-18UNEF	82.55	50.01
22	40.49	29.85	26.06	18.26	1 3/8-18UNEF	82.55	50.80
24	43.66	33.02	29.24	18.26	1 1/2-18UNEF	94.46	53.98
28	50.01	38.61	34.80	18.26	1 3/4-18UNS	94.46	55.58
32	56.36	44.96	41.15	18.26	2 -18UNS	106.38	65.89
36	62.71	50.29	46.69	18.26	2 1/4-16UN	109.14	69.06

Exploded view

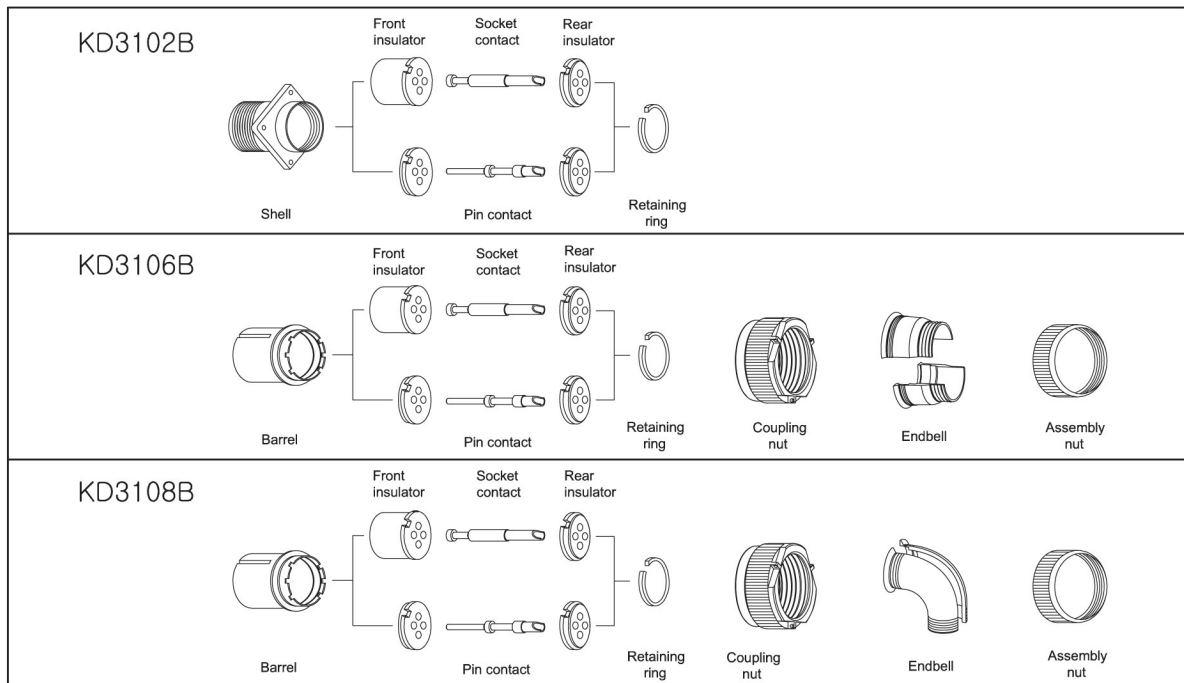

Connector Dimensions

MSW3106, Class B
Straight plug and split endbell

Wire soldering and maintenance simplified with a split type endbell

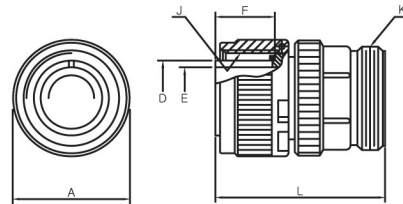

Shell size	ϕA	ϕD	ϕE	F	L	J	K
	max	-0.38	min	± 0.13	max	THD-2B	THD-2A
14s	29.36	17.15	13.36	13.49	42.88	7/8-20UNEF	3/4-20UNEF
16	31.75	20.45	16.54	18.26	52.37	1 -20UNEF	7/8-20UNEF
18	34.14	23.62	19.71	18.26	52.37	1 1/8-18UNEF	1 -20UNEF
20	37.31	26.67	23.67	18.26	55.58	1 1/4-18UNEF	1 3/16-18UNEF
22	40.49	29.85	26.06	18.26	55.58	1 3/8-18UNEF	1 3/16-18UNEF
24	43.66	33.02	29.24	18.26	58.72	1 1/2-18UNEF	1 7/16-18UNEF
28	50.01	38.61	34.80	18.26	58.72	1 3/4-18UNS	1 7/16-18UNEF
32	56.36	44.96	41.15	18.26	61.93	2 -18UNS	1 3/4-18UNS
36	62.71	50.29	46.69	18.26	61.93	2 1/4-16UN	2 -18UNS

MSW3108, Class B
90° Angle plug and split endbell

Convenient for use in narrow places

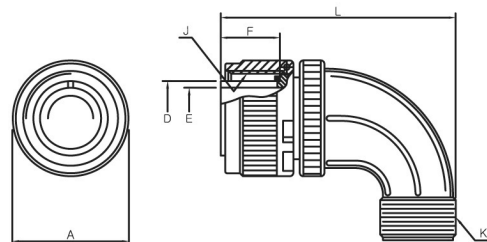

Shell size	ϕA	ϕD	ϕE	F	L	J	K
	max	-0.38	min	± 0.13	max	THD-2B	THD-2A
14s	29.36	17.15	13.36	13.49	53.98	7/8-20UNEF	3/4-20UNEF
16	31.75	20.45	16.54	18.26	65.07	1 -20UNEF	7/8-20UNEF
18	34.14	23.62	19.71	18.26	68.28	1 1/8-18UNEF	1 -20UNEF
20	37.31	26.67	23.67	18.26	76.99	1 1/4-18UNEF	1 3/16-18UNEF
22	40.49	29.85	26.06	18.26	76.99	1 3/8-18UNEF	1 3/16-18UNEF
24	43.66	33.02	29.24	18.26	86.51	1 1/2-18UNEF	1 7/16-18UNEF
28	50.01	38.61	34.80	18.26	86.51	1 3/4-18UNS	1 7/16-18UNEF
32	56.36	44.96	41.15	18.26	95.25	2 -18UNS	1 3/4-18UNS
36	62.71	50.29	46.69	18.26	100.03	2 1/4-16UN	2 -18UNS

5015 STYLE SERIES

MilSpecWest

MSW42

Dust protective caps for plug

Used with MSW06
and MSW08 plugs

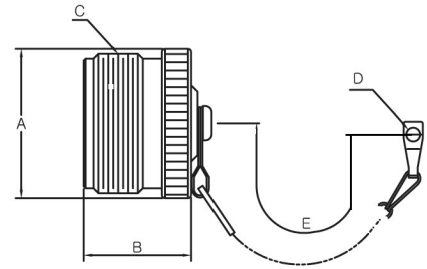

Order No.	Shell size	ϕA max	B max	C THD-2B	ϕD +0.15 -0.05	E ± 10.0
MSW42-10D	10SL	17.45	16.66	5/8-24UNEF	3.80	125.0
MSW42-12D	12s & 12	20.62	21.44	3/4-20UNEF	3.80	125.0
MSW42-14D	14s & 14	23.80	21.44	7/8-20UNEF	3.80	125.0
MSW42-16D	16s & 16	26.97	21.44	1 -20UNEF	3.80	125.0
MSW42-18D	18	30.15	21.44	1 1/8-18UNEF	3.80	125.0
MSW42-20D	20	33.32	21.44	1 1/4-18UNEF	3.80	125.0
MSW42-22D	22	36.50	21.44	1 3/8-18UNEF	3.80	125.0
MSW42-24D	24	39.67	21.44	1 1/2-18UNEF	3.80	125.0
MSW42-28D	28	46.02	21.44	1 3/4-18UNS	3.80	173.0
MSW42-32D	32	52.37	21.44	2 -18UNS	3.80	173.0
MSW42-36D	36	58.72	21.44	2 1/4-18UNS	3.80	173.0
MSW42-40D	40	65.07	21.44	2 1/2-16UN	3.80	173.0

MSW43

Dust protective caps for receptacle

Used with MSW3100, MSW3101
and MSW3102 receptacles

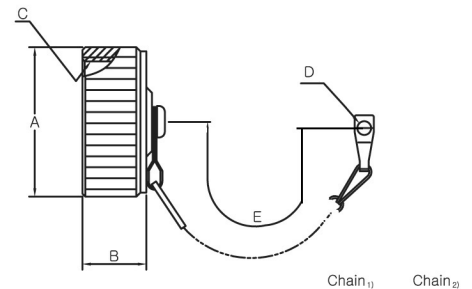

Order No.	Shell size	ϕA max	B max	C THD-2B	ϕD +0.15 -0.05	E ± 10.0
MSW43-10D	10SL	20.70	11.91	5/8-24UNEF	3.80	125.0
MSW43-12D	12s & 12	25.40	11.91	3/4-20UNEF	3.80	125.0
MSW43-14D	14s & 14	28.58	11.91	7/8-20UNEF	3.80	125.0
MSW43-16D	16s & 16	30.18	11.91	1 -20UNEF	3.80	125.0
MSW43-18D	18	34.14	11.91	1 1/8-18UNEF	3.80	125.0
MSW43-20D	20	37.31	11.91	1 1/4-18UNEF	3.80	125.0
MSW43-22D	22	40.49	11.91	1 3/8-18UNEF	3.80	125.0
MSW43-24D	24	43.66	11.91	1 1/2-18UNEF	3.80	125.0
MSW43-28D	28	50.01	13.49	1 3/4-18UNS	3.80	173.0
MSW43-32D	32	56.36	13.49	2 -18UNS	3.80	173.0
MSW43-36D	36	62.71	13.49	2 1/4-18UNS	3.80	173.0
MSW43-40D	40	69.06	13.49	2 1/2-16UN	3.80	173.0

5015 STYLE SERIES

MilSpecWest

MSW3057 Cable clamp

For plugs and receptacles that have an endbell with external conduit threads

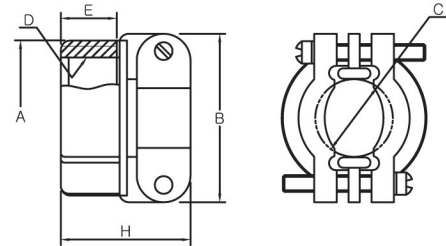

Order No.	Shell size	A ±0.79	B ±0.79	φC max	D THD-2B	E ±0.41	H ±0.79
MSW3057-	10SL, 12s & 12	20.62	22.23	7.92	5/8-24UNEF	10.31	20.62
	14s & 14	24.61	26.97	11.13	3/4-20UNEF	10.31	22.23
	16s & 16	27.79	29.36	14.27	7/8-20UNEF	10.31	23.83
	18	30.18	31.75	15.88	1 -20UNEF	10.31	23.83
	20, 22	34.93	37.31	19.05	1 3/16-18UNEF	10.31	23.83
	24, 28	42.06	42.88	23.83	1 7/16-18UNEF	10.31	26.19
	32	51.59	51.59	31.75	1 3/4-18UNS	11.91	27.79
	36	56.36	57.94	34.93	2 -18UNS	13.49	29.36

KD3420 MS3420 Bushing for cable clamps

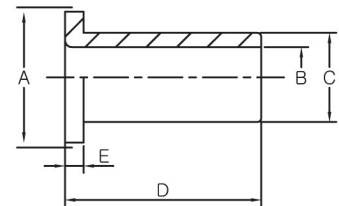
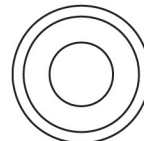

Order No.	Shell size	φA ₁ ±0.41	φA ₂ ±0.41	φB ±0.41	φC ±0.41	D ±0.79	E ₁ ±0.41	E ₂ ±0.41
KD3420-4	10SL, 12s & 12	14.66	12.83	5.59	7.67	69.85	1.60	1.57
KD3420-6	14s & 14	17.76	15.72	7.92	10.85	66.68	1.60	1.57
KD3420-8	16s & 16	20.96	18.90	11.10	14.02	63.50	1.60	1.57
KD3420-10	18	24.09	22.58	14.27	15.62	60.33	1.60	1.57
KD3420-12	20, 22	27.75	27.53	15.88	18.80	57.15	1.60	1.57
KD3420-16	24, 28	34.79	33.38	19.05	23.55	53.98	1.60	1.57
KD3420-20	32	42.93	40.59	23.80	31.50	50.80	1.60	1.57
KD3420-24	36	49.26	46.91	31.75	34.67	47.63	1.60	1.57

Note : 1) – Kukdong standard
2) – Customer's option

MSW3057 Cable clamp

For plugs and receptacles that have an endbell with external conduit threads

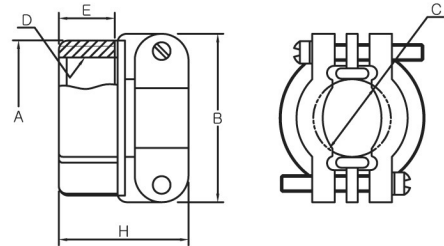

Order No.	Shell size	A ±0.79	B ±0.79	φC max	D THD-2B	E ±0.41	H ±0.79
MSW3057-4A	10SL, 12s & 12	20.62	22.23	7.92	5/8-24UNEF	10.31	20.62
MSW3057-6A	14s & 14	24.61	26.97	11.13	3/4-20UNEF	10.31	22.23
MSW3057-8A	16s & 16	27.79	29.36	14.27	7/8-20UNEF	10.31	23.83
MSW3057-10A	18	30.18	31.75	15.88	1 -20UNEF	10.31	23.83
MSW3057-12A	20, 22	34.93	37.31	19.05	1 3/16-18UNEF	10.31	23.83
MSW3057-16A	24, 28	42.06	42.88	23.83	1 7/16-18UNEF	10.31	26.19
MSW3057-20A	32	51.59	51.59	31.75	1 3/4-18UNS	11.91	27.79
MSW3057-24A	36	56.36	57.94	34.93	2 -18UNS	13.49	29.36

MSW3420 Bushing for cable clamps

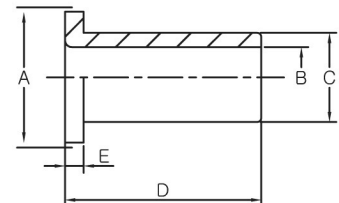
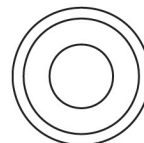

Order No.	Shell size	φA _i ±0.41	φA _o ±0.41	φB ±0.41	φC ±0.41	D ±0.79	E ±0.41
MSW3420-4A	10SL, 12s & 12	14.66	12.83	5.59	7.67	69.85	1.60
MSW3420-6A	14s & 14	17.76	15.72	7.92	10.85	66.68	1.60
MSW3420-8A	16s & 16	20.96	18.90	11.10	14.02	63.50	1.60
MSW3420-10A	18	24.09	22.58	14.27	15.62	60.33	1.60
MSW3420-12A	20, 22	27.75	27.53	15.88	18.80	57.15	1.60
MSW3420-16A	24, 28	34.79	33.38	19.05	23.55	53.98	1.60
MSW3420-20A	32	42.93	40.59	23.80	31.50	50.80	1.60
MSW3420-24A	36	49.26	46.91	31.75	34.67	47.63	1.60